

CIRCO / 無償配信 いつものTシャツA3

KIDS 80 / 100 / 120 / 140 重ね書き

A3 8枚
貼り合わせ箇所~1箇所

KIDS共通 5パーツ

前身頃・後身頃・袖・半袖・襟リブ

◆貼り合わせ図◆

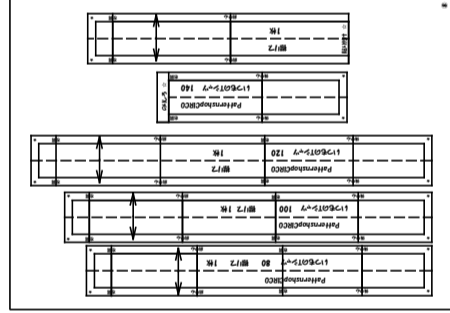
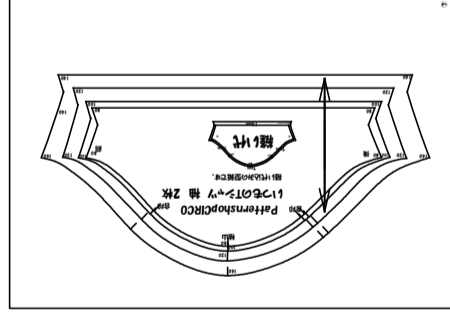
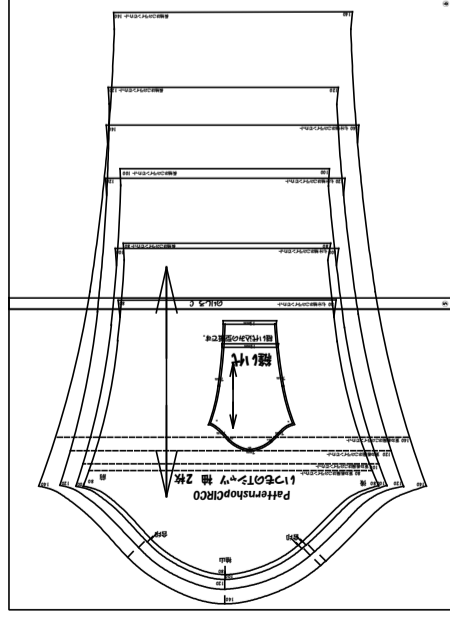
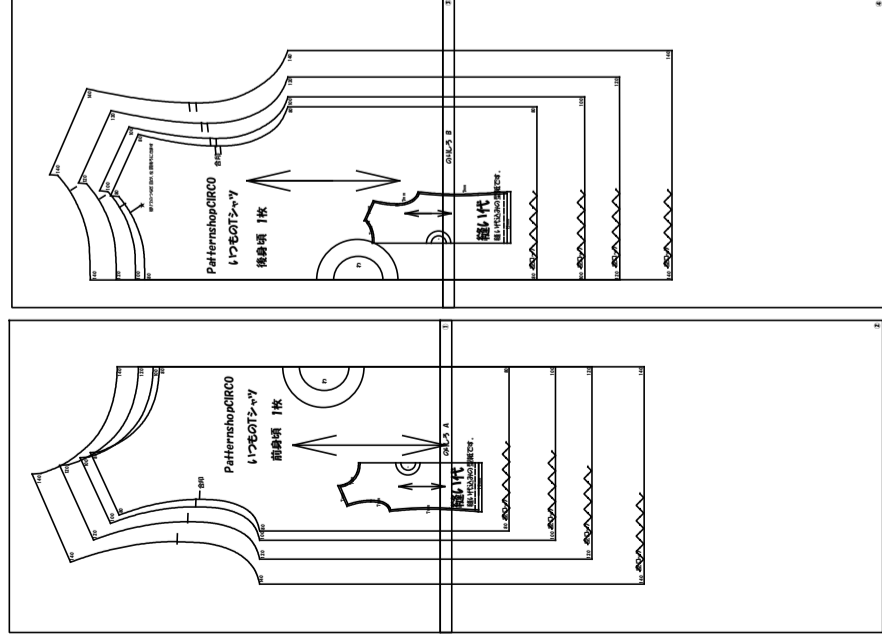

◆布地の裁断参考図◆ 160cm幅のニット生地を使用した場合の裁断図。 襟リブはサイズ表参照。高さ8cm×各サイズの長さ。

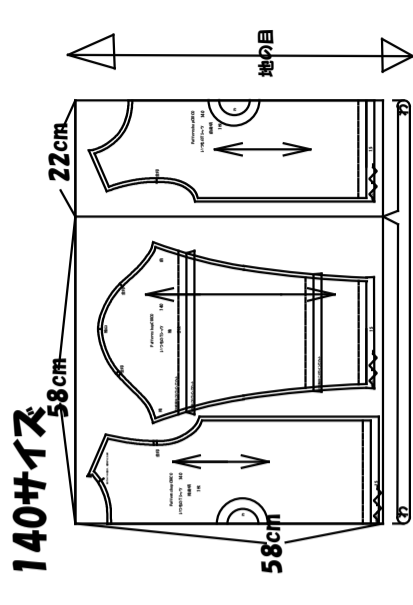
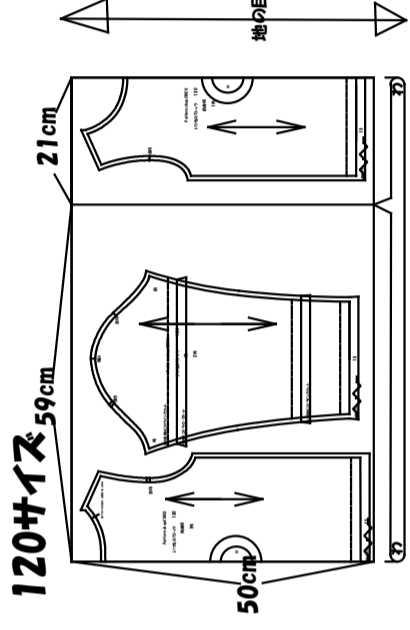
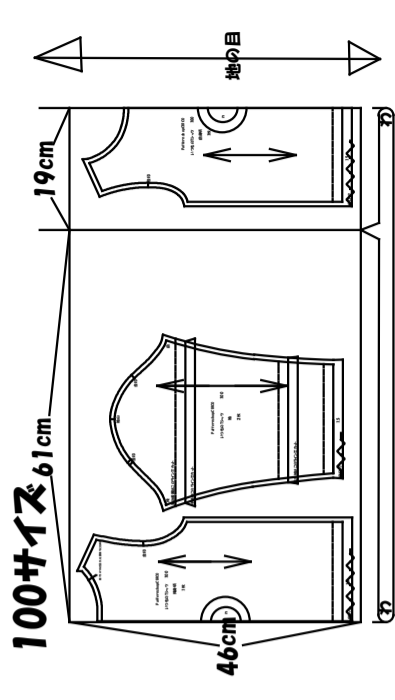
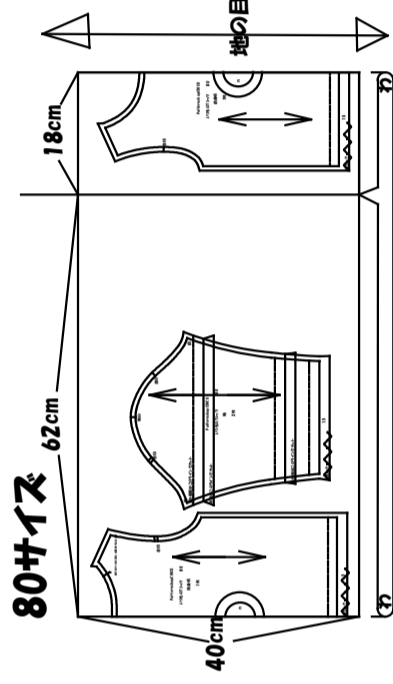

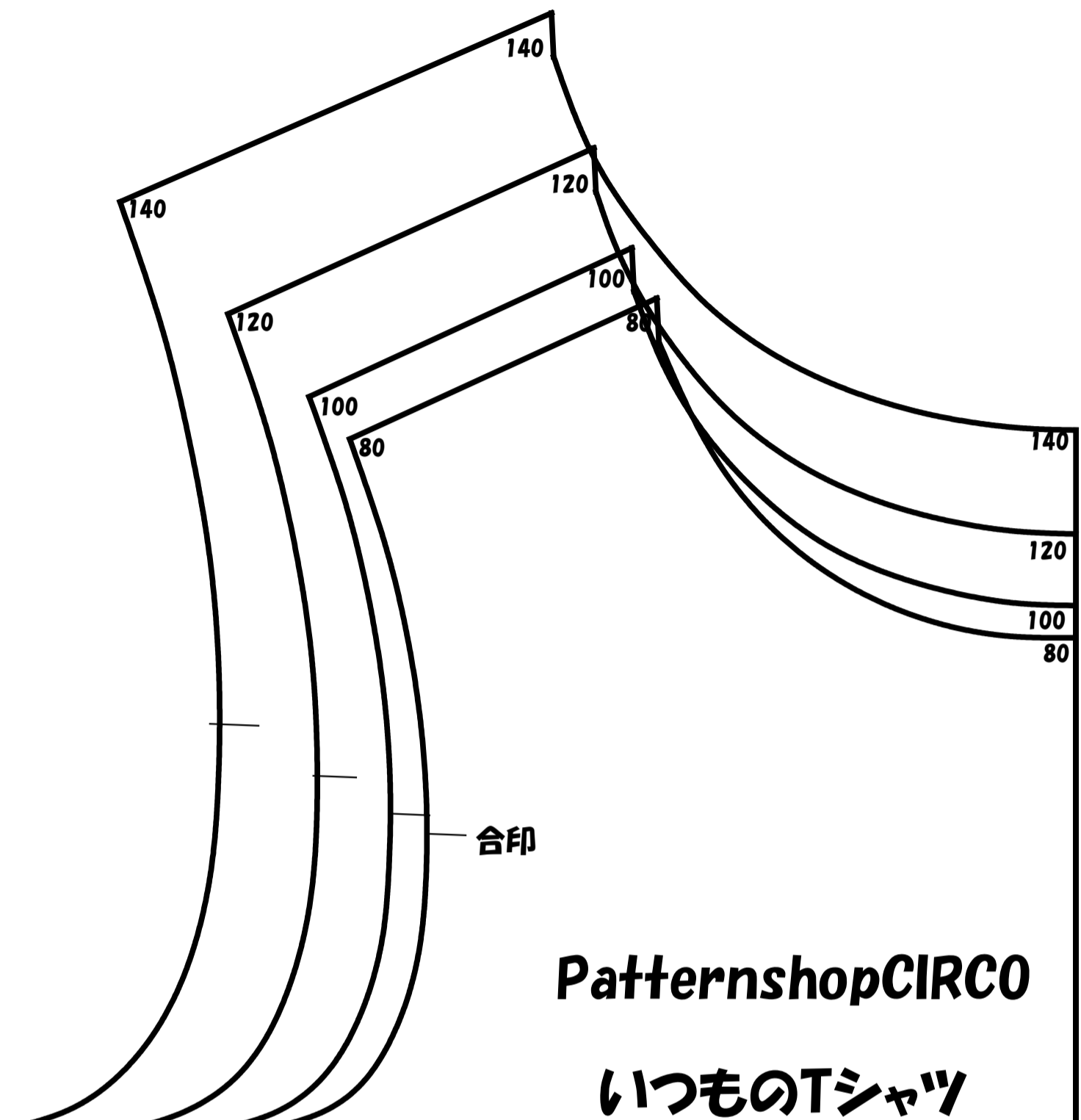

PatternshopCIRCO

いつものTシャツ

前身頃 1枚

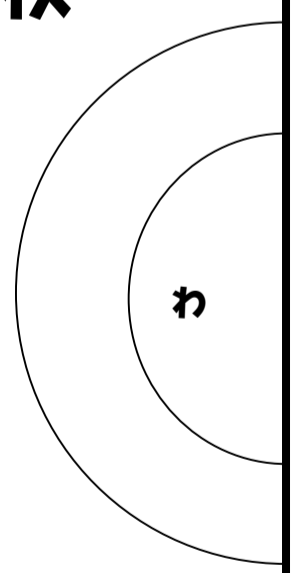
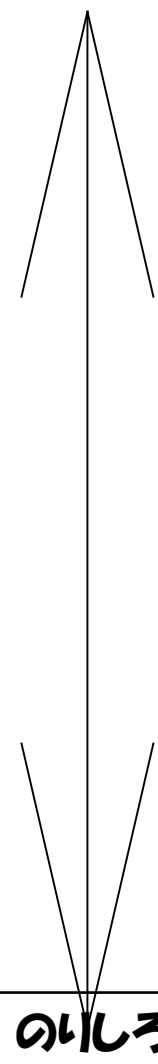
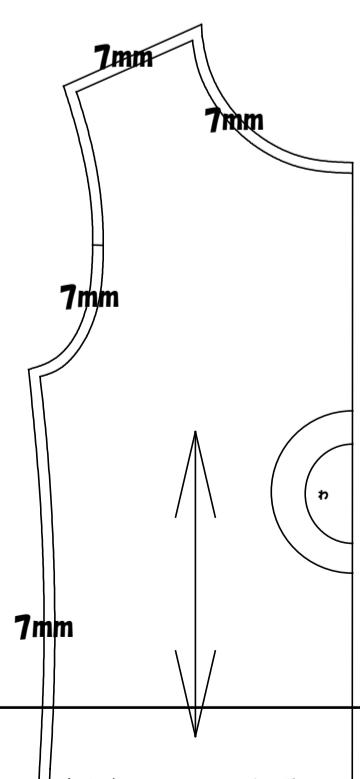
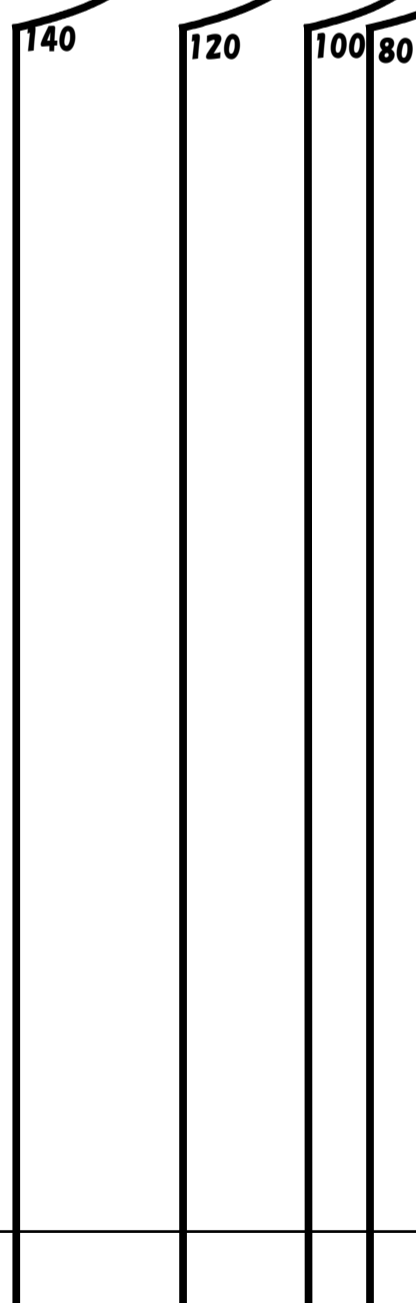

のしろ A

貼り付け A

縫い代

縫い代込みの型紙です。

15mm

80 空口ツク  80

100 空口ツク  100

120 空口ツク  120

140 空口ツク  140

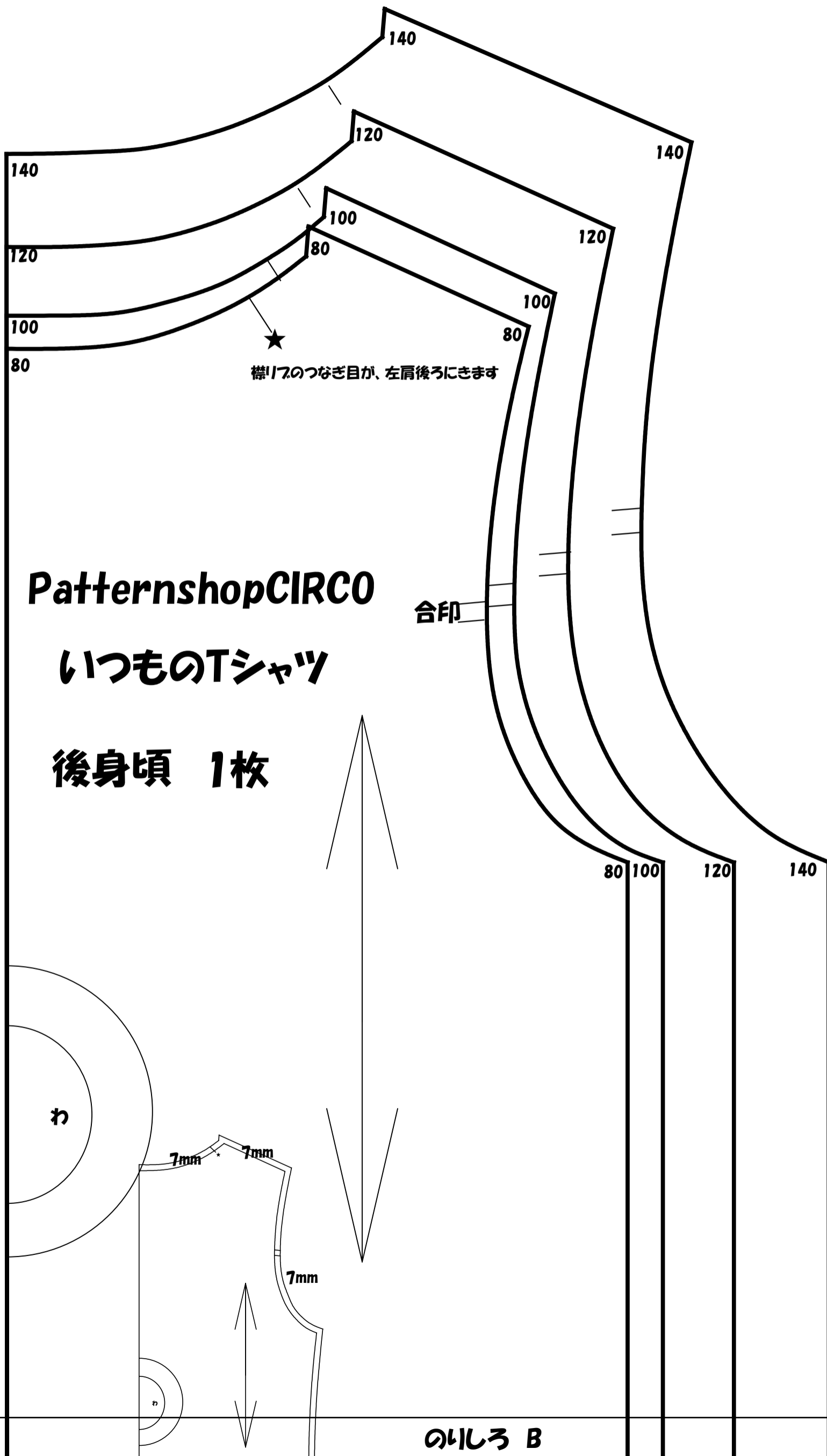

PatternshopCIRCO

いつものTシャツ

後身頃 1枚

貼り付け B



80 空口ツク  80

100 空口ツク  100

120 空口ツク  120

140 空口ツク  140

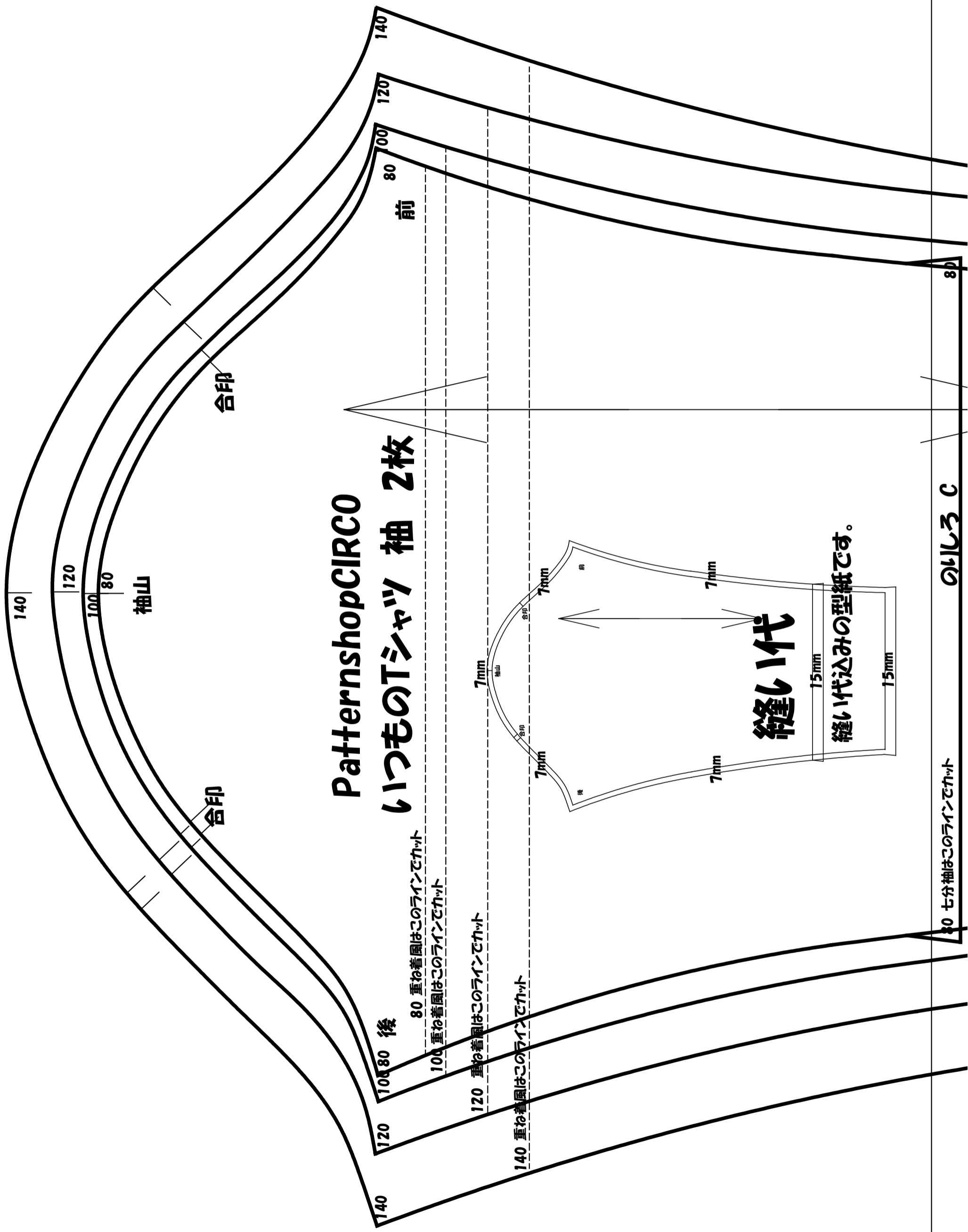

PatternshopCIRCO いつものTシャツ 袖 2枚

140 後

80 重ね着風はこのラインでカット

100 重ね着風はこのラインでカット

120 重ね着風はこのラインでカット

140 重ね着風はこのラインでカット

縫い代

縫い代込みの型紙です。

80 七分袖はこのラインでカット

のしろ C

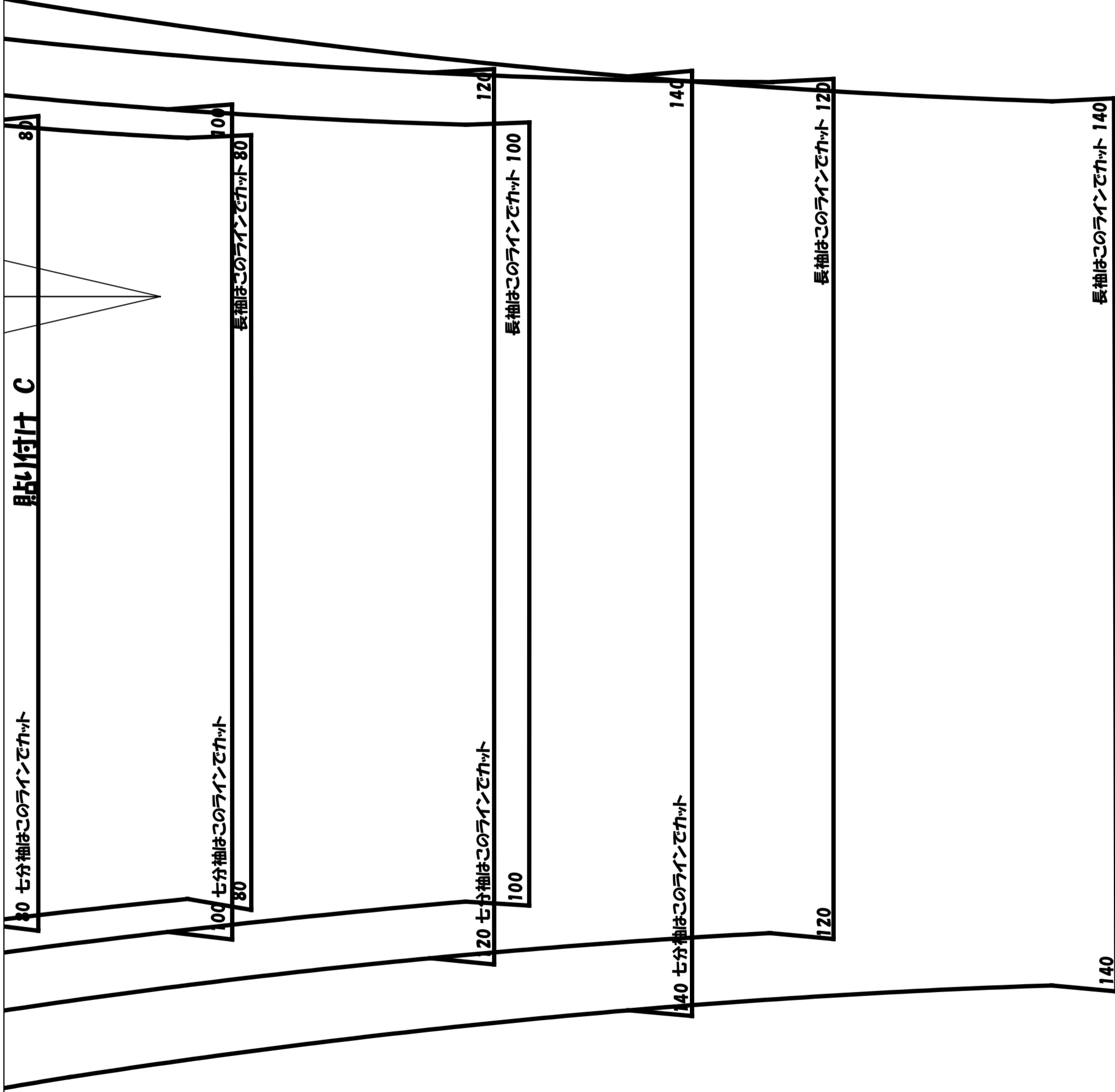

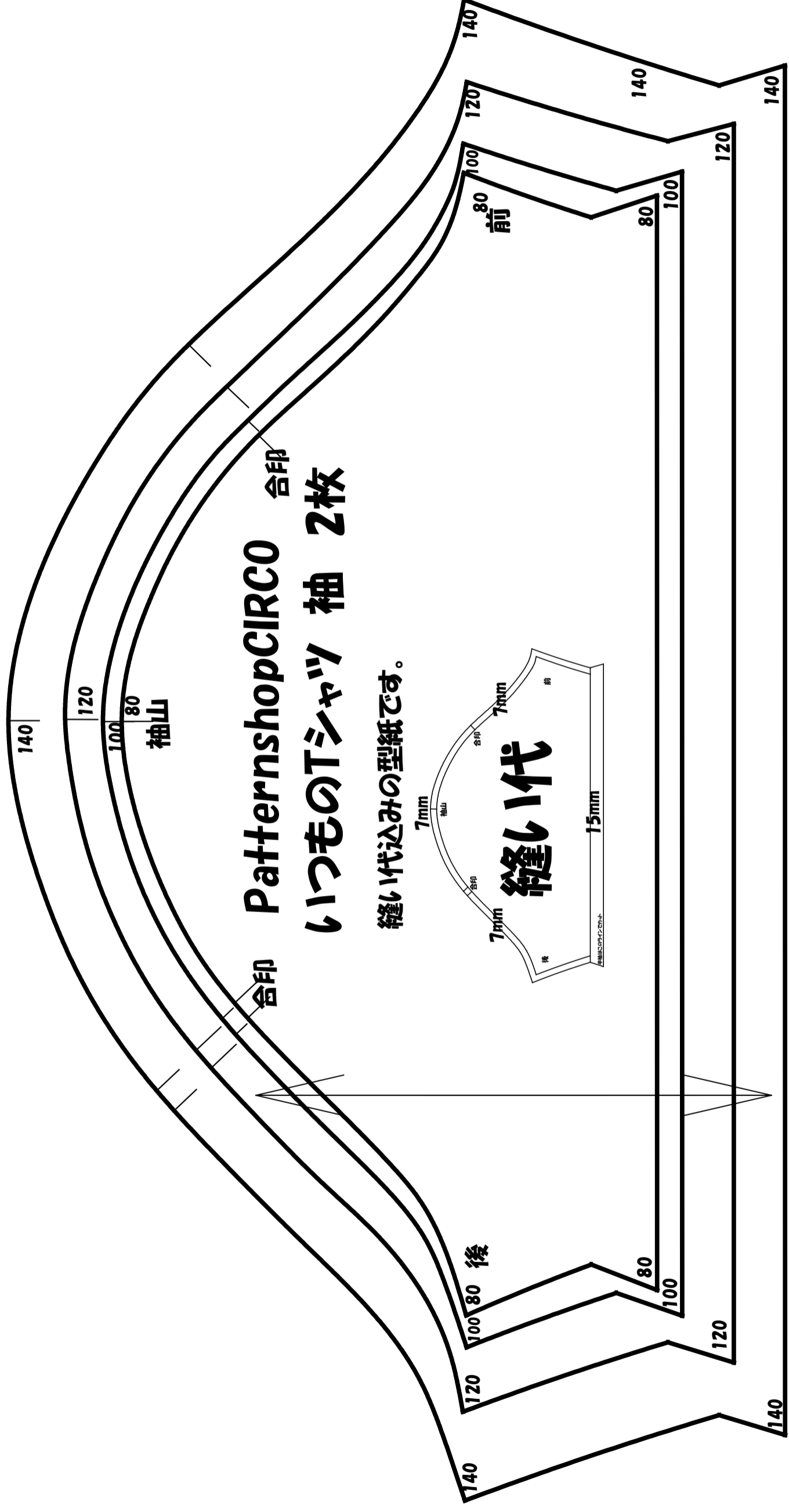

合印 PatternshopCIRCO 合印
いつものTシャツ 袖 2枚

縫い代込みの型紙です。

